

Whitepaper

Enabling Power Supplies for Automotive Camera Modules

Automotive camera modules present an interesting design challenge.

They must be small, but they also need to have tremendous range and resolution. They must be powerful, but they must consume as little power as possible. With every subsequent vehicle generation, more cameras are expected, so meeting these challenges automotive camera modules demand continuous innovation.

Automotive camera modules present an interesting design challenge. They must be small, but they also need to have tremendous range and resolution. They must be powerful, but they must consume as little power as possible. With every subsequent vehicle generation, more cameras are expected, so meeting these challenges automotive camera modules demand continuous innovation. TAIYOYUDEN offers solutions that can optimize the power supplies for these camera modules, pushing innovation to the next level.

Automotive Camera Market Overview

Electrical subsystems in automobiles are controlled by ECUs, or electronic control units. ECUs control everything from braking, to the transmission, to general electronics. Most ECUs have sensors or other control inputs, and the ECU then regulates the car's behavior or outputs based on that input. Camera modules are a common input to many different vehicle ECUs, and that number is growing.

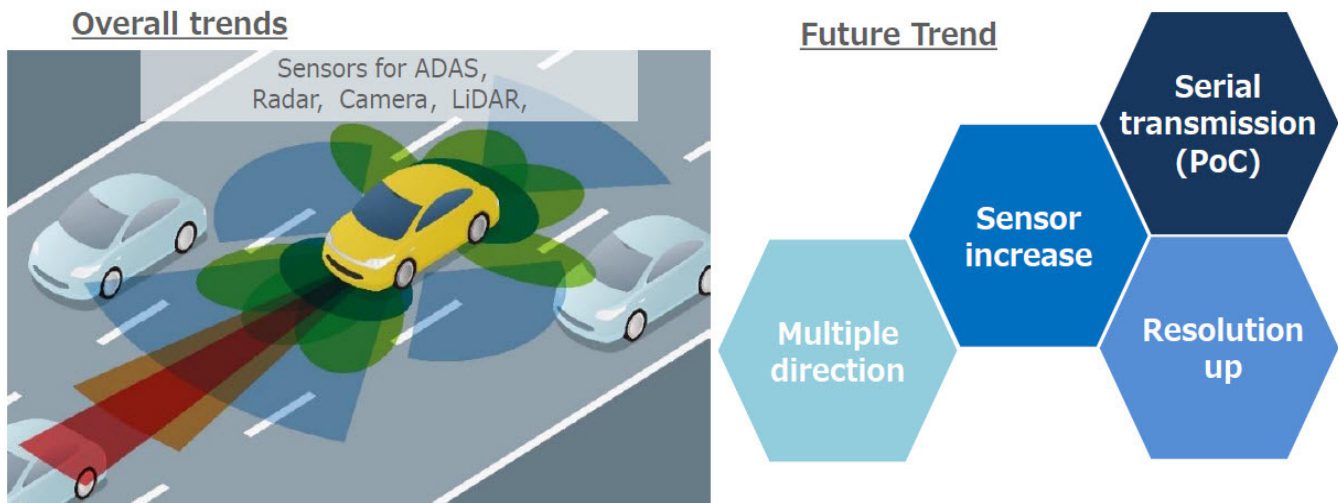

Cameras, generally provide information to two distinct sources: the driver him/herself and the driver assist systems. Drivers receive information in the form of rear view and 360 degree camera displays. Cameras also provide driver assist functions for lane drifting or collision avoidance and can even be used inside the cabin for detecting a driver that is falling asleep. As the applications of cameras in a vehicle continue to grow, the quantity of camera modules per car, and in total, also continue to grow. TAIYO YUDEN projects that by 2025 more than twice as many total camera modules will be required for automobiles, as compared to 2020.

The Challenge for Automotive Camera Module Design

As the number of camera modules increases, the requirements and complexity of them also increase. This is a compounding problem of quantity and quality: new generations are expected to be more ubiquitous, smaller, less costly, and more effective in virtually all relevant metrics. Newer automotive camera modules are expected to have a higher resolution, a faster response time, and a higher data rate. They are expected to be physically smaller, but also be more robust and last for a longer lifetime of use.

Some important technical trends in automotive camera modules are shown in Figure 1 below. In the recent past, camera modules were low pixel and operated on parallel transmission busses. They offered slower transfer speeds over different protocols, and needed less power. With all these requirements, they typically only needed to operate up to 65°C.

Today, automotive serial interfaces are more widely adopted than parallel interfaces in automotive camera sensor modules, which creates a need for larger current and higher temperature-supported components in these modules. Industry forecasts indicate that, in the near future, sensor data transfer speed will soon go up to 3.7Gbps, and the image sensor resolution will exceed 8 Megapixels.

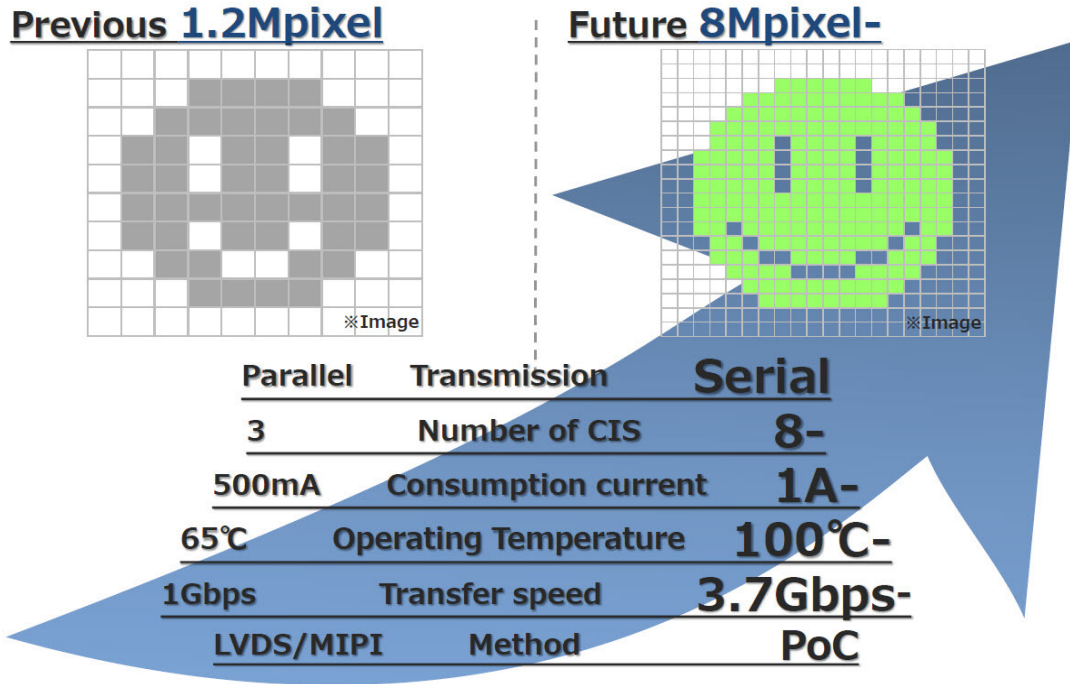

Figure 1: Technical Trends in Automotive Camera Modules

Many of these advancing requirements are driving the demand for better camera module power supplies. Camera module power supplies need to provide more power than ever before, and that power must also be clean and reliable. The power supplies, therefore, need to be very efficient and just as reliable as the cameras themselves.

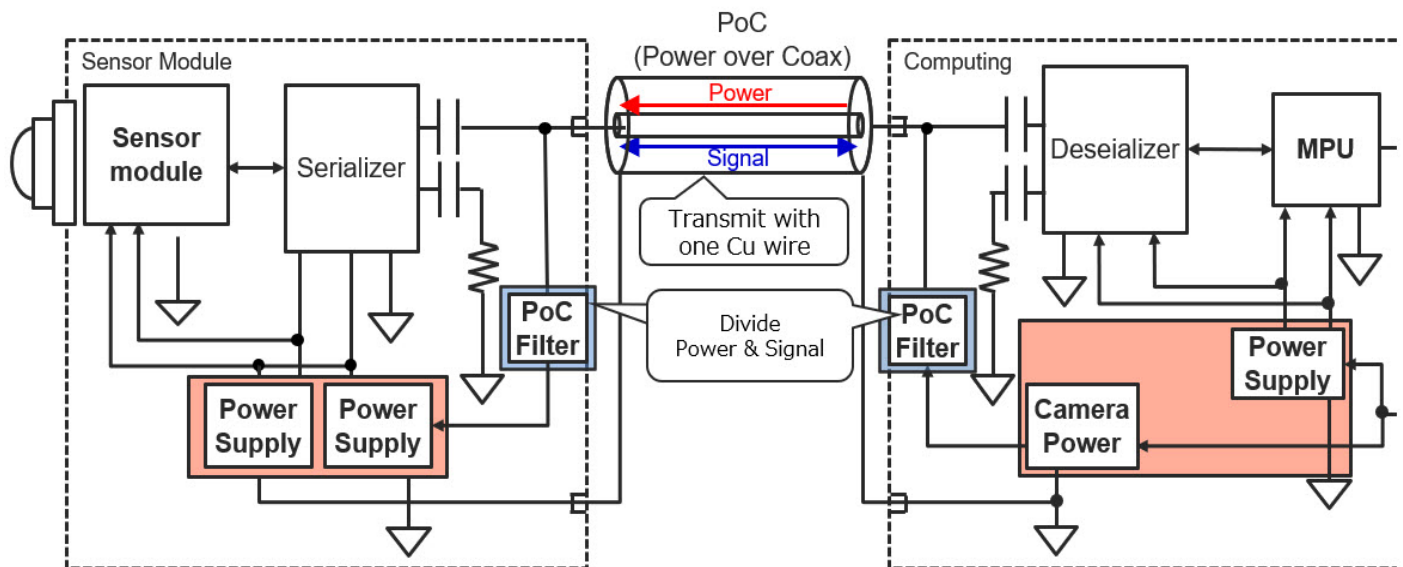

Figure 2: Block Diagram – Automotive Camera Sensor Component

As camera modules become more sensitive and more complex, they also tend to become more sensitive to electrical noise from the system. This makes the components used in power supply designs, and associated filters, critical enablers of the latest technologies.

Today, most automotive camera modules are powered using power over coax (PoC). This technology allows both high definition video and power to be transmitted from an ECU to the remotely located camera over a single coaxial cable. It's a very useful technology, but it requires filtering to separate the signal from the power, and those filtering components need to be qualified for automotive use..

TAIYO YUDEN Solutions

TAIYOYUDEN offers a number of passive components that enable the future of automotive camera module power supplies. Selecting the right inductors and capacitors for the power supply application can make the critical difference in supplies and power filters.

Inductors

TAIYOYUDEN's MCOIL™ inductor series offers a tremendous opportunity for automotive camera modules – particularly, the LCCN and LCEN series inductors, which are smaller, with better current, temperature, and frequency capabilities.

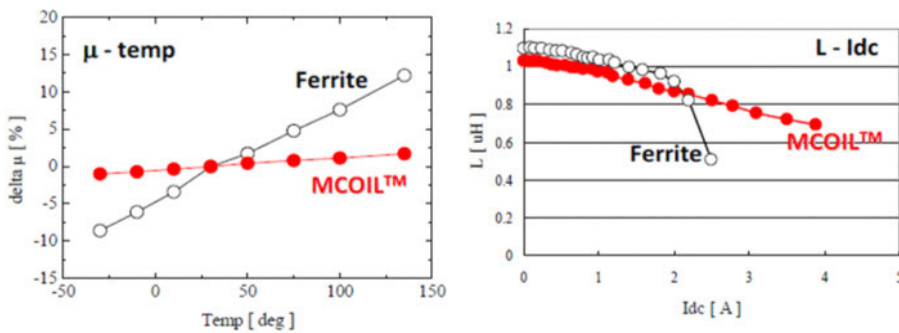

Figure 3: Performance Comparison between Typical Ferrite Inductor and MCOIL Metal Inductor

MCOIL™ metal power inductors use metallic magnetic materials that are optimized for use in choke coils for power supply circuits. These materials are used in place of ferrites, and they offer a number of advantages including temperature stability, higher current, and higher frequency. TAIYOYUDEN's original metal-magnetic materials enable excellent direct current superimposition characteristics and low magnetic flux, which yield better performance in temperature dependence and L-Idc, compared to ferrite products.

LCCN Series - Multilayer Metal Power Inductors

TAIYOYUDEN's LCCN series inductors are multilayer metal power inductors, utilizing the MCOIL™ proprietary metallic magnetic material. This series offers high currents up to more than 5A in a small package size, down to 1608. The multilayer structure allows flexibility in packaging. This series has a low magnetic flux and is rated for automotive temperatures, from 55° to 150°C.

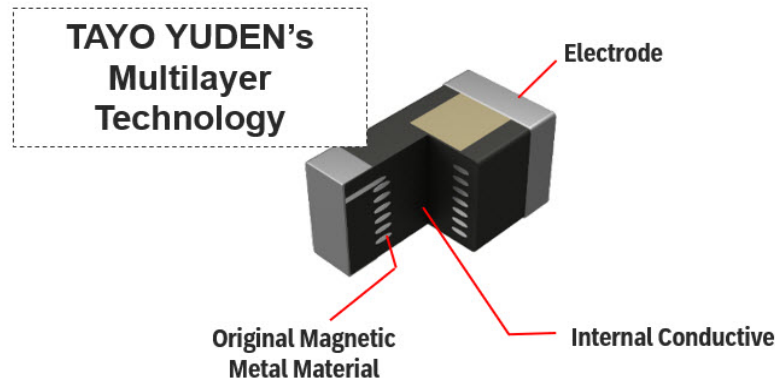

Figure 4: Combination of Unique Technologies - LCCN Series

LCEN Series - Wire-Wound Metal Power Inductors

TAIYOYUDEN's LCEN series inductors are wire-wound metal power inductors, also utilizing the MCOIL™ proprietary metallic magnetic material. The LCEN series is particularly suited for challenging automotive applications because of its high heat resistance. Additionally, the LCEN series has the following advantages:

- Lower self-heating due to copper wire connected to bottom face of inner electrode
- Superior heat transfer, suppressing self-heating
- High durability to ESD
- Lower DCR, suitable for high current applications
- Automotive temperature rating

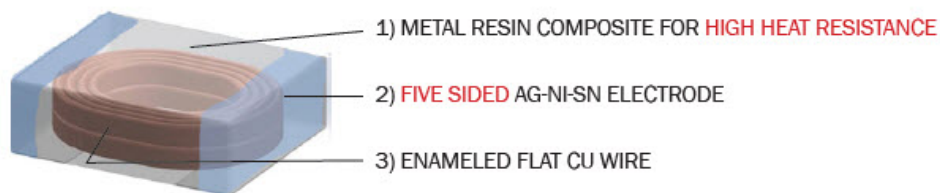
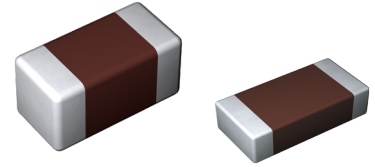

Figure 5: LCEN Series' Unique Structure

Capacitors

TAIYOYUDEN's MCAS series high reliability MLCC capacitors are well suited to automotive camera module applications due to their temperature ratings and AEC-Q200 qualification. They come in small cases with high voltage ratings. The MCAS series utilizes nickel as the electrode material which prevents migration and provides high reliability.



Conclusions

The rapidly growing automotive camera module market requires constant technical innovation to support it. The camera modules themselves are getting more technically advanced and complex, and the quantity of them per vehicle is also increasing. The components used in their power supplies and filters demand similar advancements. TAIYOYUDEN stands ready to provide many components to enable these innovations. From metallic magnetic power inductors such as the LCCN and LCEN series MCOIL™ products, to the high reliability MCAS series capacitors, automotive camera module power supplies can be more reliable than ever before.

"MCOIL" is a registered trademark or a trademark of TAIYOYUDEN CO., LTD. in Japan and other countries. The names of series noted in the text are excerpted from part numbers that indicate the types and characteristics of the products, and therefore are neither product names nor trademarks.

TAIYOYUDEN (U.S.A.) INC.
2077 Gateway Place, Suite 350
San Jose, CA 95110
United States
www.t-yuden.com

This paper's information is subject to change without notice.

©2022 TAIYOYUDEN (U.S.A.) INC.

All Rights Reserved

Pub: July 2022

Follow us on social media.

